

Dear customer

Thank you for purchasing this product.
For optimum performance and safety, please read these instructions carefully.

These operating instructions fundamentally explain the operation of RX-D16.

The model number and serial number of this product can be found on either the back or the bottom of the unit. Please note them in the space provided below and keep for future reference.

MODEL NUMBER _____

SERIAL NUMBER _____

User memo:

DATE OF PURCHASE _____

DEALER NAME _____

DEALER ADDRESS _____

TELEPHONE NUMBER _____

Supplied accessories



Please check and identify the supplied accessories. Use numbers indicated in parentheses when asking for replacement parts.

(Only for U.S.A.)

To order accessories contact 1-800-332-5368 or web site (<http://www.panasonic.com>).

- AC power supply cord (polarized) (RJA0065-1D) 1pc

None

The included AC power supply cord is for use with this unit only. Do not use it with other equipment.

- Remote control transmitter **RX-D16 and RX-D14 only** 1pc (EUR648257)

Panasonic®

Portable Stereo CD System

Operating Instructions

Model No. **RX-D16**
RX-D14
RX-D144

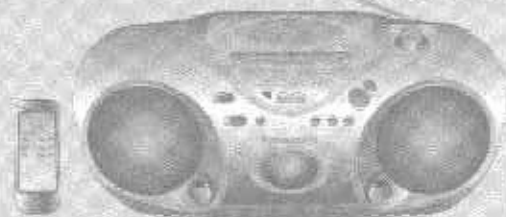

The illustrations show RX-D16.
(RX-D144 is for CANADA only.)



Before connecting, operating or adjusting this product, please read these instructions completely.

Please keep this manual for future reference.

P PC PL

Power sources

The unit can be powered with household AC power or dry cell batteries (not included). Insert memory batteries (not included) to save stored CD programs and radio stations.

Using a household AC outlet

Connect the power cord firmly to the unit and the outlet.

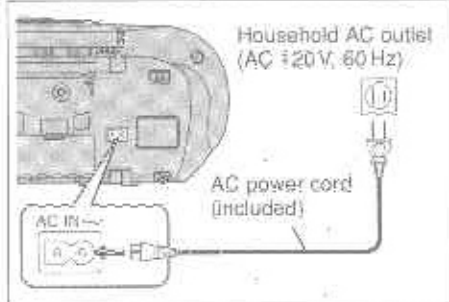

- Before connecting or disconnecting the cord, stop the tape and switch [RECORD] to "TAPE/STOP" to turn the power off. The memory batteries are worn out faster if the cord is disconnected with the power still on.

Conserving power

The unit consumes 1W even when it is turned off with [RECORD]. To save power when the unit is not to be used for a long time, unplug it from the household AC outlet. Remember to reset the radio stations and any other memory items before using the unit again if you haven't inserted memory batteries.

Using batteries

The unit cannot be powered by batteries if the power cord is connected.

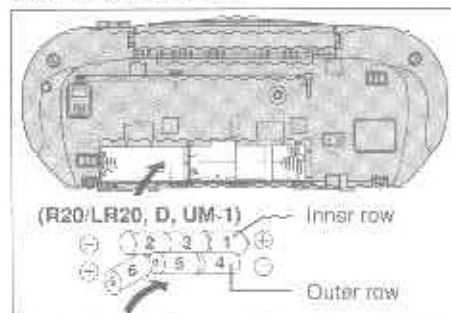

When to change the batteries

Sound quality and operations are affected when the batteries are running low. Replace all six batteries. It is also a good idea to replace all the batteries before recording.

Removing the batteries

Open the battery cover and insert your finger in the hole on the bottom of the unit and push out



Memory back-up

Insert batteries (not included) to save CD programs and radio stations you have set. If memory batteries are not used, memory items are erased in the following situations.

- Power failures.
- The power cord is disconnected from the power outlet.
- The power cord is connected to the unit while the unit is being powered by batteries.

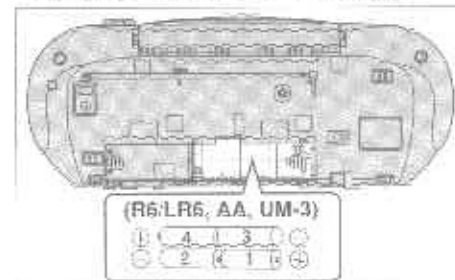

When to change the batteries

The batteries last about a year. Connect the unit to AC power before replacing the batteries.

Removing the batteries

Press the negative end of the number 4 battery and remove the batteries. (Remove the power batteries first.)

Controls

Main unit:

(For RX-D16 and RX-D14 only)
Remote control signal sensor (SENSOR)

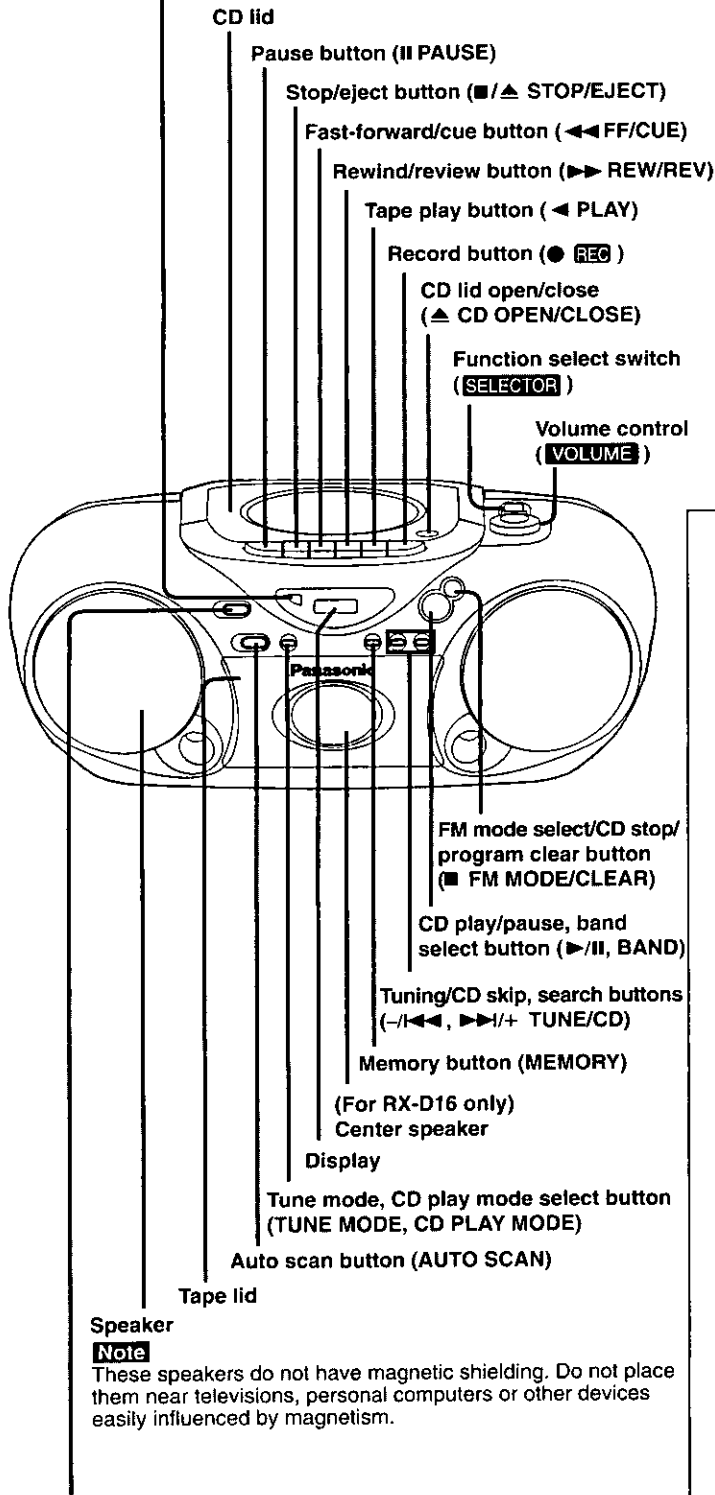

XBS button (XBS)
Press to boost the bass sound.
Press again to turn off.

Note
These speakers do not have magnetic shielding. Do not place them near televisions, personal computers or other devices easily influenced by magnetism.

Remote control:

(The remote control is available only for RX-D16 and RX-D14.)
The functions of the buttons without descriptions are the same as on the main unit.

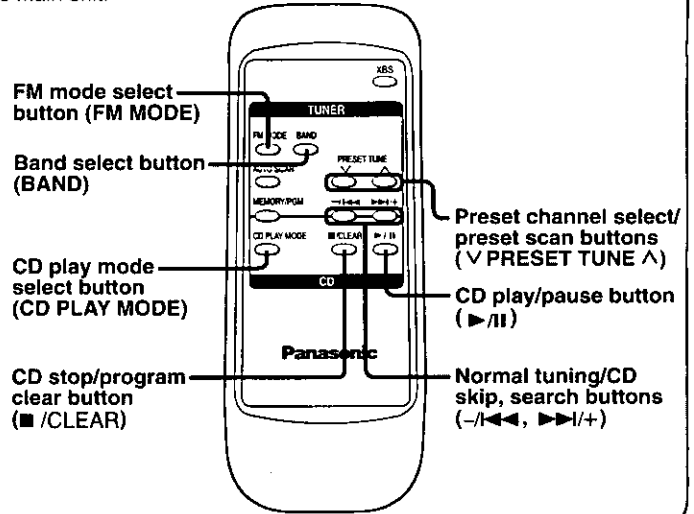

Concerning the remote control

(For RX-D16 and RX-D14 only)

Battery installation

Insert the batteries (not included) observing the correct polarities (⊕, ⊖).

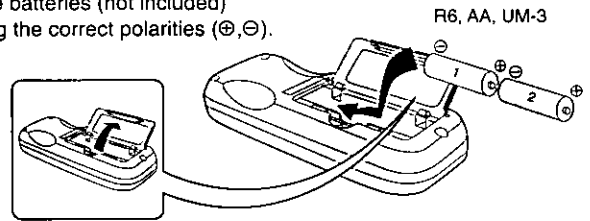

Correct method of use

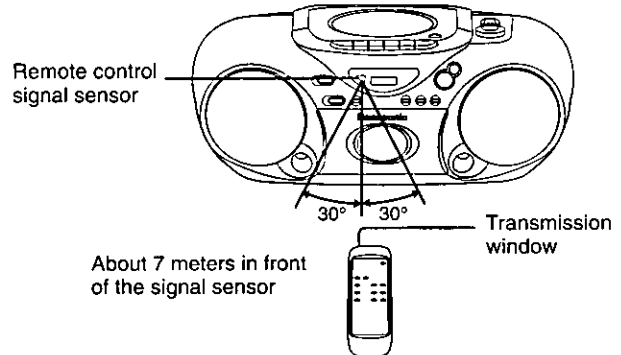

Operation notes

- Do not place obstacles between the remote control signal sensor and the remote control unit.
- Do not expose the remote control signal sensor to direct sunlight or to the bright light of fluorescent light.
- Take care to keep the remote control signal sensor and end of the remote control unit free from dust.

To prevent damage

- Never place heavy items on it.
- Do not disassemble or reconstruct it.
- Do not spill water or other liquids into it.

Listening to radio broadcasts

Normal tuning

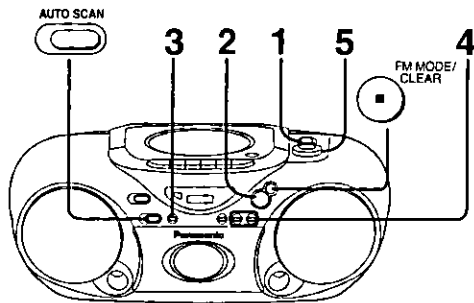

- 1 Switch **[SELECTOR]** to "TUNER".
(Power comes on.)
- 2 Press **[BAND]** to select "FM" or "AM".
- 3 (Omit this step if using the remote control)
If "PGM" is on the display, press **[TUNE MODE]** to clear it off.
- 4 Press **[-/|<<]** or **[>>|/+]** to tune to the desired station.
The frequency changes one step each time a button is pressed.

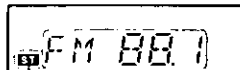
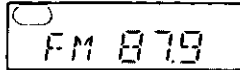

Automatic tuning

Keep **[-/|<<]** or **[>>|/+]** depressed and release when the frequency display starts to change. A station with good reception is automatically selected and the process stops. To stop automatic tuning, press **[-/|<<]** or **[>>|/+]** again.

Note

Automatic tuning may stop on a frequency where there is no station if there is interference. Press **[-/|<<]** and **[>>|/+]** to tune if this occurs.

5 Adjust the volume.

To use auto scan

You can search for a station by listening to all tuned-in stations for 8 seconds each.

Preparation: Switch **[SELECTOR]** to "TUNER".

1. Press **[BAND]** to select "FM" or "AM".
2. Press **[AUTO SCAN]**.
Auto scan starts.



3. Press **[AUTO SCAN]** when you find the desired station.
Auto scan ends when it reaches the original frequency again.
To stop during the process, press **[AUTO SCAN]**.

To improve reception

FM: Extend the whip antenna and adjust its direction.

AM: Adjust facing of the unit.

If noise is excessive in the FM stereo mode
Press **[FM MODE]**. ("MONO" lights up.)

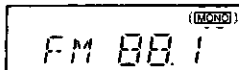

Sound will be produced in monaural, but this also reduces noise.
Press the button again to cancel. ("MONO" goes out.)

To receive FM broadcasts allocated in 0.1 MHz

(Only from the main unit)

First press **[BAND]** to select "AM". Now, press and hold **[BAND]**. The display changes in a few seconds to show the current lowest FM frequency. Continue to hold down the button.

The minimum frequency changes and the step is changed at the same time. Changing the step erases all preset stations.

Repeat the above to change the step back.

Preset tuning

Preset the stations (twelve FM and twelve AM) to make tuning simpler.

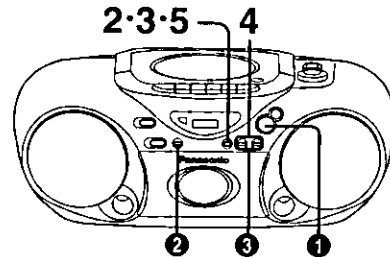

- 1 Tune to the desired station.
Do steps 1-4 on the left.

- 2 Press **[MEMORY]**.

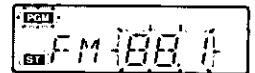

- 3 While "PGM" and the frequency are flashing
Press **[MEMORY]**.

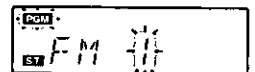

Preset channel

- 4 While "PGM" and the preset channel are flashing
Press **[-/|<<]** or **[>>|/+]** to select the desired channel.
(Remote control: **[V]** or **[A]**)

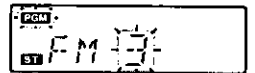

- 5 Press **[MEMORY]**.
(This completes presetting.)

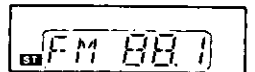

- 6 Repeat steps 1-5 to preset other stations.

Note

If "PGM" goes off during presetting, return to step 2.

To listen to preset channels

- 1 Press **[BAND]** to select "FM" or "AM".

- 2 (Omit this step if using the remote control)
Press **[TUNE MODE]** to display "PGM".

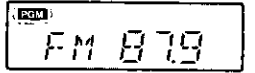

- 3 Press **[-/|<<]** or **[>>|/+]** to select the desired channel (1-12).
(Remote control: **[V]** or **[A]**)



Preset channel

To use preset scan

You can search for a station by listening to all preset channels for 8 seconds each.

1. Do steps 1 to 2 above.

For remote control, replace **[-/|<<]** or **[>>|/+]** described below with **[V]** or **[A]**.

2. Press and hold **[-/|<<]** or **[>>|/+]** until "PS" appears on the display.



3. Press **[-/|<<]** or **[>>|/+]** when you find the desired channel.

Preset scan ends after searching through each preset channel once.
To stop during the process, press **[-/|<<]** or **[>>|/+]**.

Listening to CDs

Normal play

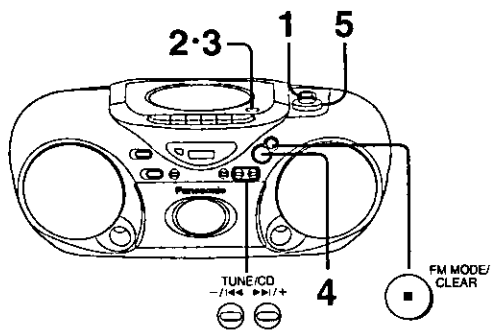

- 1 Switch [SELECTOR] to "CD".
(Power comes on.)

- 2 Push [▲ CD OPEN/CLOSE] to open the CD lid and insert the CD.

Label must face upward.

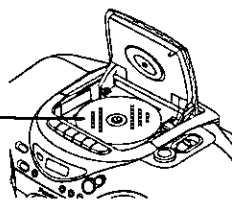

- 3 Push [▲ CD OPEN/CLOSE] to close the CD lid.

Total playing time

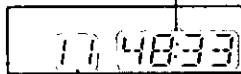

Total number of tracks

Elapsed play time

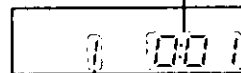

Track number in play

- 4 Press [▶/||] to start play.
Play starts from the first track and continues to the last track.

- 5 Adjust the volume.

To stop play
Press [■].

To pause	Press [▶/] during playback. To resume, press [▶/].
To search forward/backward	Hold down [←/⏮] (backward) or [→/⏭] (forward) during playback or when paused.
To skip forward/backward	Press [←/⏮] (backward) or [→/⏭] (forward) during playback or when paused.

"NO DISC" is displayed if there is no disc in the unit.

Note

- If interference occurs to radios or televisions, place the unit as far as possible from this equipment.
- Do not press [▲ CD OPEN/CLOSE] during play, pause or immediately after you inserted the CD and closed the CD lid. CD may be scratched.

This unit can play CD-DA (digital audio) format audio CD-R that has been finalized (a process that enables CD-R players to play audio CD-R) upon completion of recording. It may not be able to play some CD-R due to the condition of the recording. It cannot play CD-RW.

Program play

You can program up to 24 tracks.

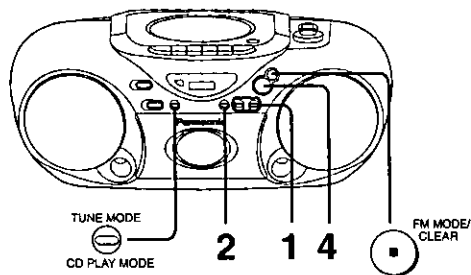

Ensure CD is stopped before programming.

- 1 Press [←/⏮] or [→/⏭] to select the desired track.

Track number Play time



- 2 Press [MEMORY].
The track is programmed.

Program order

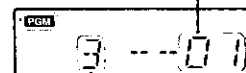

Specified track number

- 3 Repeat steps 1 and 2 until you have programmed all the tracks you want.

Total play time of programmed tracks

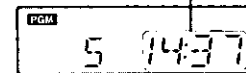

- 4 Press [▶/||].
Play starts in the programmed order.

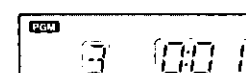

To stop play

Press [■].

"P" is displayed indicating that the program is still active.

Press [■] again and "CLR" is displayed; the program is cleared, and the normal play mode is restored.

To check program contents

Press [←/⏮] or [→/⏭] when "P" is displayed.

Display

"---:--": Program equals, or exceeds, 100 minutes but programming and play are still possible.

"FULL": 24 tracks have already been programmed. The program is full.

CD play modes

You can repeat one track (1-🔁), all tracks (🔁) or play the tracks in random order (RANDOM).

Press [CD PLAY MODE] before or during playback to select the desired mode.

→ 1-🔁 → 🔁 → [RANDOM] → off (no indication)

These modes remain active until canceled.
You can use repeat mode with program play.

Note

Random and program play cannot be done at the same time.

Listening to tapes

This unit is suitable for playing normal tapes, but high and metal position tapes will not be played to their full potential.

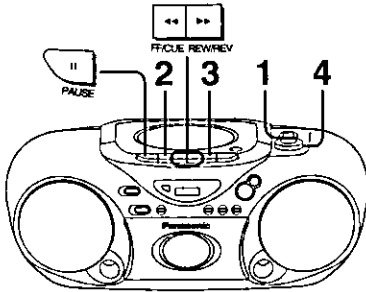

1 Switch [SELECTOR] to "TAPE/OFF".

2 Press [STOP/EJECT] to open the tape lid and load the tape.
Close the tape lid by hand.

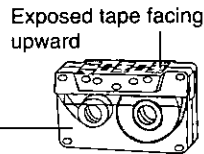

3 Press [PLAY] to start play.
Power comes on and play starts.



4 Adjust the volume.

To stop play

Press [STOP/EJECT]. (Power is switched off.)

To pause	Press [PAUSE] during playback. To resume, press [PAUSE].
To rewind/ fast-forward	Press [REW/REV] (to rewind) or [FF/CUE] (to fast-forward) <u>in the stop mode</u> .
To find a particular spot	Press [REW/REV] (to search backward) or [FF/CUE] (to search forward) <u>during playback</u> . Play is resumed when the button is released.

Note

- The unit's power is on in the pause mode. Stop tape to turn the unit off by pressing [STOP/EJECT] when leaving the unit.
- Do not press [PLAY] when rewinding or fast-forwarding, as this may jam the tape.
Be sure to press [STOP/EJECT] before the next operation.

Full auto-stop

The automatic stop system will release the buttons when the tape reaches the end during play, recording, fast forwarding or rewinding.

Recording

You can record radio broadcasts or CDs.

Before recording

- This unit is suitable for recording normal tapes, but it cannot record onto high and metal position tapes to their full potential and prior recordings will not be erased correctly.
- The recording level is set automatically.
- Take up the leader tape before proceeding.



Leader tape (Recording cannot be made.)

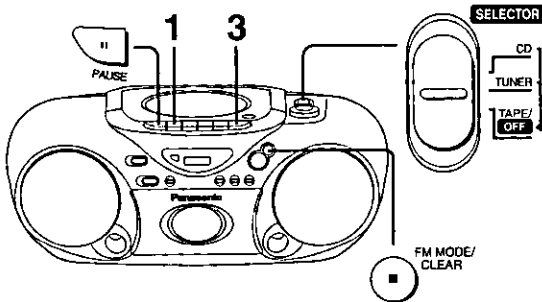

1 Press [STOP/EJECT] to open the tape lid and load the tape.
Close the tape lid by hand.

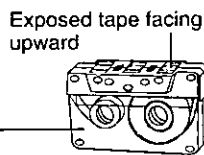

2 Select the source to be recorded.
When recording radio broadcasts

Tune in the station.
(Do steps 1-4 of "Normal tuning" on page 3.)

When recording CDs

Insert the CD to be recorded.
(Do steps 1-3 of "Normal play" on page 4.)

If you want to record programmed tracks, program desired tracks before proceeding to step 3.

3 Press [REC] to start recording.

[PLAY] is also depressed with [REC].
Recording starts (one side only).
The CD also starts playing if in CD mode.

To stop recording

Press [STOP/EJECT]. (The CD does not stop.)

To stop recording temporarily

Press [PAUSE]. (The CD does not stop.)
Press once again to resume recording.

To record on the other side of the tape

Turn the tape over and press [REC].

If the CD finishes before the tape

Recording continues. Press [STOP/EJECT] to stop it.

If the tape finishes before the CD

The CD continues playing. Press [STOP] to stop it.

Note

Noise may be recorded if this unit is near a TV. Keep the units at least 1.5 meters apart.

Erasure prevention

Use a screwdriver or similar object to break out the tab.

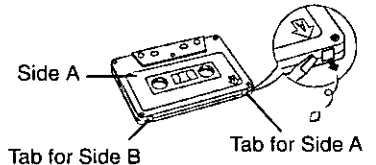

To re-record on a protected cassette
Cover the hole with adhesive tape.

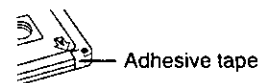

To erase a tape

- Set [SELECTOR] to "TAPE/OFF".
- Insert the tape with the side to be erased facing towards you and the exposed tape facing up.
- Press [REC].
[PLAY] is depressed at the same time.

Reference

Changes to volume and sound quality do not affect recording.
To prevent interruptions to recording, supply AC power to the unit or replace the batteries.

Using headphones (not included)

Turn down the volume and connect the headphones to the [PHONES] jack.

Plug type: 3.5 mm (1/8") stereo

Note

Avoid listening for prolonged periods of time to prevent hearing damage.

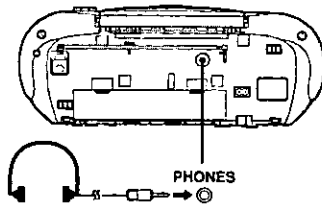

Maintenance

Cleaning inside the deck

Clean the heads regularly to assure good quality playback and recording. Use a cleaning tape (not included).

Care of the CD lens

Clean the lens regularly to prevent malfunctions. Use a blower to remove dust and a cotton swab if it is extremely dirty.

Recommended product:

Lens cleaner kit (part no. SZZP1038C).

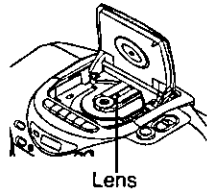

Product Service

- 1. Damage requiring service**—The unit should be serviced by qualified service personnel if:
 - (a) The AC power supply cord or AC adaptor has been damaged; or
 - (b) Objects or liquids have gotten into the unit; or
 - (c) The unit has been exposed to rain; or
 - (d) The unit does not operate normally or exhibits a marked change in performance; or
 - (e) The unit has been dropped or the cabinet damaged.
- 2. Servicing**—Do not attempt to service the unit beyond that described in these operating instructions. Refer all other servicing to authorized servicing personnel.
- 3. Replacement parts**—When parts need replacing ensure the servicer uses parts specified by the manufacturer or parts that have the same characteristics as the original parts. Unauthorized substitutes may result in fire, electric shock, or other hazards.
- 4. Safety check**—After repairs or service, ask the servicer to perform safety checks to confirm that the unit is in proper working condition.

Product Information

For product information or assistance with product operation: In the U.S.A., contact the Panasonic Customer Call Center at 1-800-211-7262, or e-mail consumerproducts@panasonic.com, or web site (<http://www.panasonic.com>).

In Canada, contact Panasonic Canada Inc. Customer Care Centre at 905-624-5505, web site (www.panasonic.ca), or an authorized Servicentre closest to you.

Listening caution



Selecting fine audio equipment such as the unit you've just purchased is only the start of your musical enjoyment. Now it's time to consider how you can maximize the fun and excitement your equipment offers. This manufacturer and the Electronic Industries Association's Consumer Electronics Group want you to get the most out of your equipment by playing it at a safe level. One that lets the sound come through loud and clear without annoying blaring or distortion—and, most importantly, without affecting your sensitive hearing.

We recommend you to avoid prolonged exposure to excessive noise.

Sound can be deceiving. Over time your hearing "comfort level" adapts to higher volumes of sound. So what sounds "normal" can actually be loud and harmful to your hearing.

Guard against this by setting your equipment at a safe level BEFORE your hearing adapts.

To establish a safe level:

- Start your volume control at a low setting.
- Slowly increase the sound until you can hear it comfortably and clearly, and without distortion.

Once you have established a comfortable sound level:

- Set the dial and leave it there.

Taking a minute to do this now will help to prevent hearing damage or loss in the future. After all, we want you listening for a lifetime.

CAUTION!

THIS PRODUCT UTILIZES A LASER.

USE OF CONTROLS OR ADJUSTMENTS OR PERFORMANCE OF PROCEDURES OTHER THAN THOSE SPECIFIED HEREIN MAY RESULT IN HAZARDOUS RADIATION EXPOSURE. DO NOT OPEN COVERS AND DO NOT REPAIR YOURSELF. REFER SERVICING TO QUALIFIED PERSONNEL.

CAUTION:

TO PREVENT ELECTRIC SHOCK MATCH WIDE BLADE OF PLUG TO WIDE SLOT, FULLY INSERT.

WARNING:

TO REDUCE THE RISK OF FIRE, ELECTRIC SHOCK OR PRODUCT DAMAGE, DO NOT EXPOSE THIS APPARATUS TO RAIN, MOISTURE, DRIPPING OR SPLASHING AND THAT NO OBJECTS FILLED WITH LIQUIDS, SUCH AS VASES, SHALL BE PLACED ON THE APPARATUS.



CAUTION

**RISK OF ELECTRIC SHOCK
DO NOT OPEN**



CAUTION: TO REDUCE THE RISK OF ELECTRIC SHOCK, DO NOT REMOVE SCREWS. NO USER-SERVICEABLE PARTS INSIDE. REFER SERVICING TO QUALIFIED SERVICE PERSONNEL.



The lightning flash with arrowhead symbol, within an equilateral triangle, is intended to alert the user to the presence of uninsulated "dangerous voltage" within the product's enclosure that may be of sufficient magnitude to constitute a risk of electric shock to persons.



The exclamation point within an equilateral triangle is intended to alert the user to the presence of important operating and maintenance (servicing) instructions in the literature accompanying the appliance.

IMPORTANT SAFETY INSTRUCTIONS

Read these operating instructions carefully before using the unit. Follow the safety instructions on the unit and the safety precautions listed below. Keep these operating instructions handy for future reference.

Safety

- 1. Power source**—Connect the unit to a power source of the type described in these instructions or as marked on the unit.
- 2. Polarization**—The unit is equipped with a polarized power plug where one blade is wider than the other. This safety feature ensures that the plug fits into your household AC outlet only one way. If the plug doesn't fit one way, try reversing it. If the plug still doesn't fit, contact an electrician to replace the obsolete outlet. Do not attempt to defeat the safety purpose of the plug.
- 3. Power cord protection**—Route the AC power supply cord so that it will not be walked on or pinched by items placed on or against it. Never take hold of the plug or cord with wet hands. Always grasp the plug body firmly when connecting and disconnecting it.
- 4. Overloading**—When connecting the AC power supply cord, be careful not to overload the household AC outlet, extension cord, or outlet from any other device as this can result in fire or electric shock.
- 5. Nonuse periods**—Turn the unit off when it is not in use. Unplug the unit from the household AC outlet if it is not to be used for a long time. Unplug the unit during lightning storms.
- 6. Attachments and accessories**—Use only the attachments and accessories recommended in these operating instructions.

Installation

Placement

- 1. Ventilation**—Situate the unit so that it receives proper ventilation. Do not install in a confined space such as a bookcase or cabinet. Allow at least 10 cm (4 inches) clearance from the rear of the unit. To prevent the risk of electric shock or fire due to overheating ensure curtains and other materials do not obstruct the unit's ventilation.
- 2. Foreign material**—Ensure objects and liquids do not get into the unit. Avoid exposing the unit to excessive smoke, dust, mechanical vibration, and shock.
- 3. Magnetism**—Situate the unit away from equipment and devices that generate strong magnetic fields.
- 4. Stacking**—Do not place heavy objects on top of this unit.
- 5. Surface**—Place the unit on a flat, level surface.
- 6. Carts and stands**—Use the unit only with carts and stands recommended by the manufacturer. Move carts with care. Sudden stops, excessive force, and uneven surfaces can cause carts to overturn. 
- 7. Wall and ceiling mounting**—Do not mount the unit on walls or ceilings unless specified in the instructions.

Environment

- 1. Water and moisture**—Do not use the unit near water, such as near a bathtub or swimming pool. Avoid damp basements.
- 2. Heat**—Situate the unit away from heat sources, such as radiators. Do not situate where temperatures fall below 5°C (41°F) or rise above 35°C (95°F).

CAUTION!

DO NOT INSTALL, OR PLACE THIS UNIT, IN A BOOKCASE, BUILT-IN CABINET OR IN ANOTHER CONFINED SPACE. ENSURE THE UNIT IS WELL VENTILATED. TO PREVENT RISK OF ELECTRIC SHOCK OR FIRE HAZARD DUE TO OVERHEATING, ENSURE THAT CURTAINS AND ANY OTHER MATERIALS DO NOT OBSTRUCT THE VENTILATION VENTS.

Maintenance

(See page 6 for details.)

Unplug the unit from the household AC outlet before cleaning. Clean with a damp cloth. Do not use abrasive pads, scouring powders, or solvents.

Service

- 1. Damage requiring service**—The unit should be serviced by qualified service personnel if:
 - (a) The AC power supply cord or the plug has been damaged; or
 - (b) Objects or liquids have gotten into the unit; or
 - (c) The unit has been exposed to rain; or
 - (d) The unit does not operate normally or exhibits a marked change in performance; or
 - (e) The unit has been dropped or the cabinet damaged.
- 2. Servicing**—Do not attempt to service the unit beyond that described in these operating instructions. Refer all other servicing to authorized servicing personnel.
- 3. Replacement parts**—When parts need replacing ensure the servicer uses parts specified by the manufacturer or parts that have the same characteristics as the original parts. Unauthorized substitutes may result in fire, electric shock, or other hazards.
- 4. Safety check**—After repairs or service, ask the servicer to perform safety checks to confirm that the unit is in proper working condition.

Use of batteries

- Align the poles (+ and -) properly when inserting the batteries.
- Do not mix old and new batteries or different types of batteries.
- Do not recharge ordinary dry cell batteries.
- Do not heat or disassemble the batteries. Do not allow them to contact flame or water.
- If the unit is not going to be used for a long time or if the unit is to be powered exclusively by AC power, remove the batteries and store them in a cool, dark place.
- Do not keep together with metallic objects such as necklaces.
- Do not use rechargeable type batteries.
- Do not use batteries if the covering has been peeled off.

Mishandling of batteries can damage other items, cause damage to the unit, and may cause a fire through short-circuiting or electrolyte leakage. If electrolyte leaks from the batteries, consult your dealer. Wash thoroughly with water if electrolyte comes in contact with any part of your body.

THE FOLLOWING APPLIES ONLY IN THE U.S.A.

CAUTION:

This equipment has been tested and found to comply with the limits for a Class B digital device, pursuant to Part 15 of the FCC Rules. These limits are designed to provide reasonable protection against harmful interference in a residential installation. This equipment generates, uses and can radiate radio frequency energy and, if not installed and used in accordance with the instructions, may cause harmful interference to radio communications. However, there is no guarantee that interference will not occur in a particular installation. If this equipment does cause harmful interference to radio or television reception, which can be determined by turning the equipment off and on, the user is encouraged to try to correct the interference by one or more of the following measures:

- Reorient or relocate the receiving antenna.
- Increase the separation between the equipment and receiver.
- Connect the equipment into an outlet on a circuit different from that to which the receiver is connected.
- Consult the dealer or an experienced radio/TV technician for help.

Any unauthorized changes or modifications to this equipment would void the user's authority to operate this device.

This device complies with Part 15 of the FCC Rules. Operation is subject to the following two conditions: (1) This device may not cause harmful interference, and (2) this device must accept any interference received, including interference that may cause undesired operation.

Audio software

Take note of the following points to extend the life of your equipment. Always read the instructions provided with the software.

Discs

Choose discs with this mark:

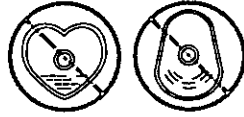

Continued use of irregular shaped CDs can damage the unit.

Do not;

- use discs that have extra labels or stickers attached. Carefully remove leftover adhesive before use.
- attach scratch-proof covers or any other kind of accessory.
- write anything on the CD.
- clean CDs with liquids. Wipe with a soft, dry cloth.
- use CDs printed with label printers available on the market.
- load a blank CD-R as it will cause abnormal malfunction and may damage the CD-R.

Tapes

- Tapes exceeding 100 minutes are thin and can break or get caught in the mechanism.
- Tape slack can get caught up in the mechanism and should be taken up before the tape is played.
- Endless tapes can get caught up in the deck's moving parts if used incorrectly.

Specifications

Frequency range	87.9–107.9MHz (200kHz steps)
FM	87.5–108.0MHz (100kHz steps)
	520–1710kHz (10kHz steps)
AM	44.1 kHz
Sampling frequency	16 bit linear
Decoding	2 channel, stereo
Beam source	Semiconductor laser (wavelength 780 nm)
No. of channels	Less than possible measurement data
Wow and flutter	1 bit DAC
D/A converter	4 track, 2 channel, stereo
Track system	Variable sound monitor
Monitor system	AC bias
Recording system	Multi Pole magnet
Erasing system	
Frequency range	50–12000Hz
Normal position	
Speakers	
Full range	10cm (3 ¹⁵ / ₁₆ ") 4Ω x 2
Center speaker (For RX-D16 only)	1.5 cm (1 ⁹ / ₃₂ ")
Jacks	
Output	PHONES: 3.5 mm stereo (32Ω)
Power requirement	
AC	120V, 60Hz
Battery	Power consumption: 14 W
	9V (Six R20/LR20, D, UM-1 batteries)
	• Do not use rechargeable type batteries.
	6V (Four R6/LR6, AA, UM-3 batteries)
	• Do not use rechargeable type batteries.
Memory back-up	
Dimensions (WxHxD)	420 x 167 x 275 mm (16 ¹¹ / ₃₂ " x 6 ³¹ / ₃₂ " x 10 ¹³ / ₁₆ ")
Mass	(RX-D16) 3.6kg (7 lb. 15 oz.) without batteries
	(RX-D14/RX-D144) 3.4 kg (7 lb. 8 oz.) without batteries
Power consumption in standby mode: 1W	

Note

Specifications are subject to change without notice. Mass and dimensions are approximate.

Troubleshooting guide

Before requesting service, make the below checks. If you are in doubt about some of the check points, or if the remedies indicated in the chart do not solve the problem:
In the U.S.A., contact the Panasonic Customer Call Center at 1-800-211-7262, or e-mail consumerproducts@panasonic.com, or web site (<http://www.panasonic.com>).
In Canada, contact Panasonic Canada Inc. Customer Care Centre at 905-624-5505, web site (www.panasonic.ca), or an authorized Servicentre closest to you.

Common Problem

The unit doesn't work on batteries.	Is the AC power cord connected to the unit? Disconnect when using batteries. Have the batteries been inserted correctly? Check that the poles (+ and -) are correctly aligned.
"UO1" is displayed.	Replace the batteries or use household AC power.

CD

"E" is displayed.	Indicates an incorrect operation. Read the instructions.
Play doesn't start or display is incorrect.	Clean the CD. Wait for an hour for condensation to dry, then try again. Make sure the label is facing up. Replace the CD if it is scratched, warped, or irregularly shaped.

Cassette

Recording not possible.	Has the cassette's tab been removed? Cover the hole with adhesive tape.
Poor sound quality.	Clean the heads.
The cassette cannot be ejected or the lid can't be closed when loading a cassette.	The batteries are flat. Replace the batteries or connect to household AC power. Press [◀ PLAY] then [■/▲ STOP/EJECT].

Radio

A lot of noise.	Is another remote control being used? Use it further away from this unit. Is a TV on? Move the unit away from the TV or turn it off.
-----------------	---

Remote control (available only for RX-D16 and RX-D14)

The remote control doesn't work.	Check the batteries are inserted correctly. Replace the batteries if they are worn.
----------------------------------	--

Panasonic Consumer Electronics Company, Division of Matsushita Electric Corporation of America
 One Panasonic Way Secaucus, New Jersey 07094
<http://www.panasonic.com>

Panasonic Sales Company, Division of Matsushita Electric of Puerto Rico, Inc. ("PSC")
 Ave. 65 de Infantería, Km. 9.5 San Gabriel Industrial Park, Carolina, Puerto Rico 00985

Panasonic Canada Inc.
 5770 Ambler Drive Mississauga, Ontario L4W 2T3
www.panasonic.ca

